



BIMA Cx40

Mass production to batch size 1

ima.de

BIMA Cx40

4- and 5-axes CNC-processing centre

BIMA Cx40 – the new series of ergonomic CNC machining centres with integrated C-axis for high-quality and flexible processing of furniture components and internal construction parts in individual small batch production and › lot size 1‹ fabrication. An intelligent machine concept with minimum processing times for maximum economy.



BIMA CX40
EN 04/2017



Energy-efficient production

Protection of the environment and energy efficiency are standard features of the BIMA Cx40 series: Examples of this include the integrated standby mode, optimized extraction of the processing units, minimal usage of compressed air, and energy-efficient drive technology.



EUROPÄISCHE UNION
Investition in unsere Zukunft
Europäischer Fonds
für regionale Entwicklung

OVERVIEW

The optimal combination of high-quality machine construction and intelligent process control in all system parts allows every customer-specific solution.



TOOL CHANGE POSITION

with extension onto Pick-up for e. g. 350 mm saw blade

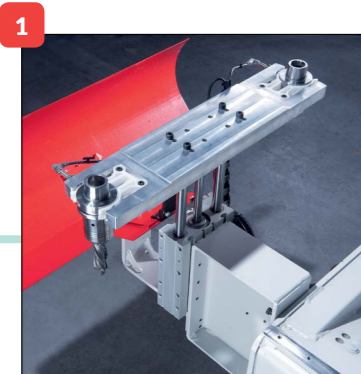

CONSOLE TABLE

or automatic setting table

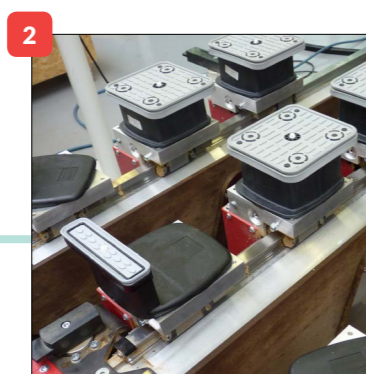

TOOL CHANGER

with 18 to 40 tool slots

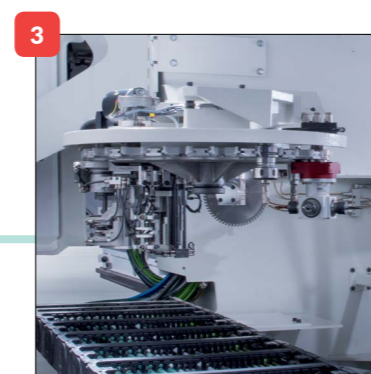

OPTIMAL VIEWING

and user-friendly inspection of the machining area

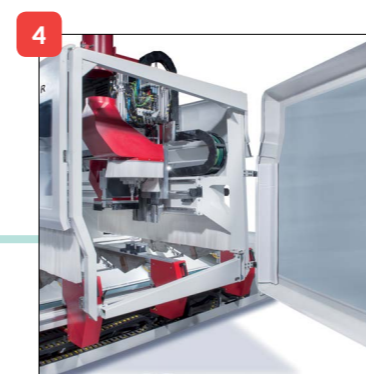

MACHINING UNIT

customer-specific mounting

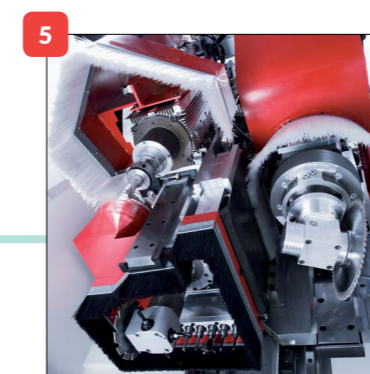

EDGING UNIT

VT series, laser unit or combined unit

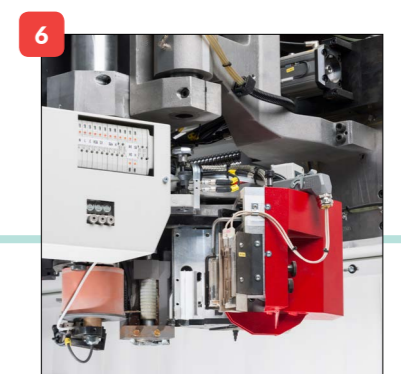

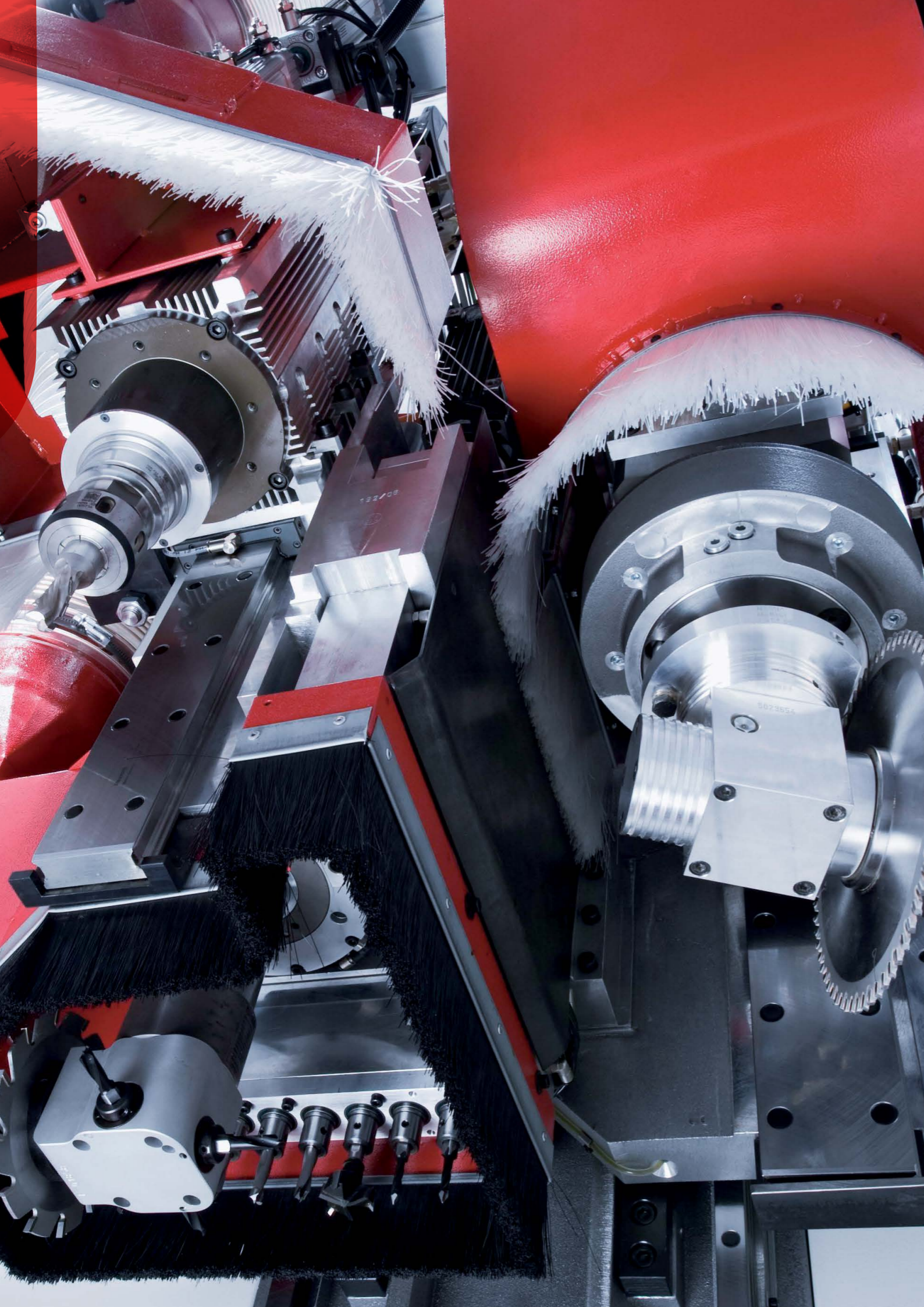

DETAILS OF MODEL RANGE

The BIMA Cx40 series stands for maximum flexibility in complete processing on a minimum setup area. With the option to be set up as a milling, banding or 5-axis machine, the BIMA Cx40 series offers leading edge technology.

BIMA CX40 MILLING

For sophisticated "batch size 1" fabrication and small batch production:

- stairs
- windows
- external doors
- internal doors
- furniture fronts
- furniture components
- worktops
- lightweight construction boards
- aluminium sections
- frontage elements

! 4.5-axis machining with optional Vario-NC

BIMA CX40 E EDGING

Exactly tailored to your customers' needs: The wide choice of various edge banding units as well as laser units allows optimal complete processing of:

- furniture fronts & furniture components
- worktops
- lightweight construction boards

! 4.5-axis machining with optional Vario-NC

BIMA CX40 R 5-AXIS MACHINING

The extremely stable machine for extreme milling tasks with powerful 5-axis head such as:

- stairs
- windows
- external doors
- internal doors
- aluminium sections
- frontage elements

! 5-axis router spindle



EDGING

The high-performance and flexible machining centre for complete processing. In addition to sizing and milling operations, it gives you the possibility to band decorative and functional edging materials to the side faces of straight or curved parts.

IMA LASER EDGING UNIT FREE-FORM PARTS

- combined unit for EVA, PUR and laser edging by manual conversion for full flexibility in future
- patented collision control for damage protection
- all required adjustments on the unit are program controlled
- wear-free laser system thanks to fixed optics
- integrated infrared camera for absolutely safe process monitoring (option)
- manually changeable pressing roll from 100 mm to 50 mm

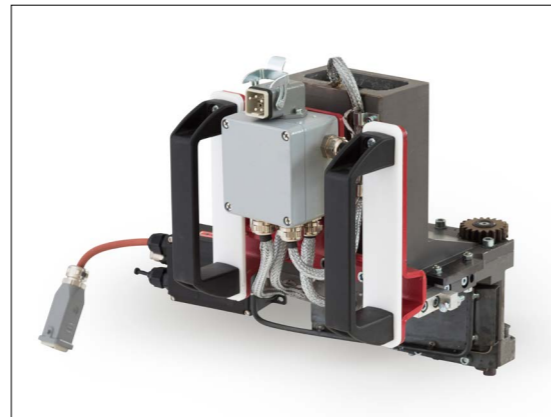

manual tooling unit for conventional edging within the laser unit

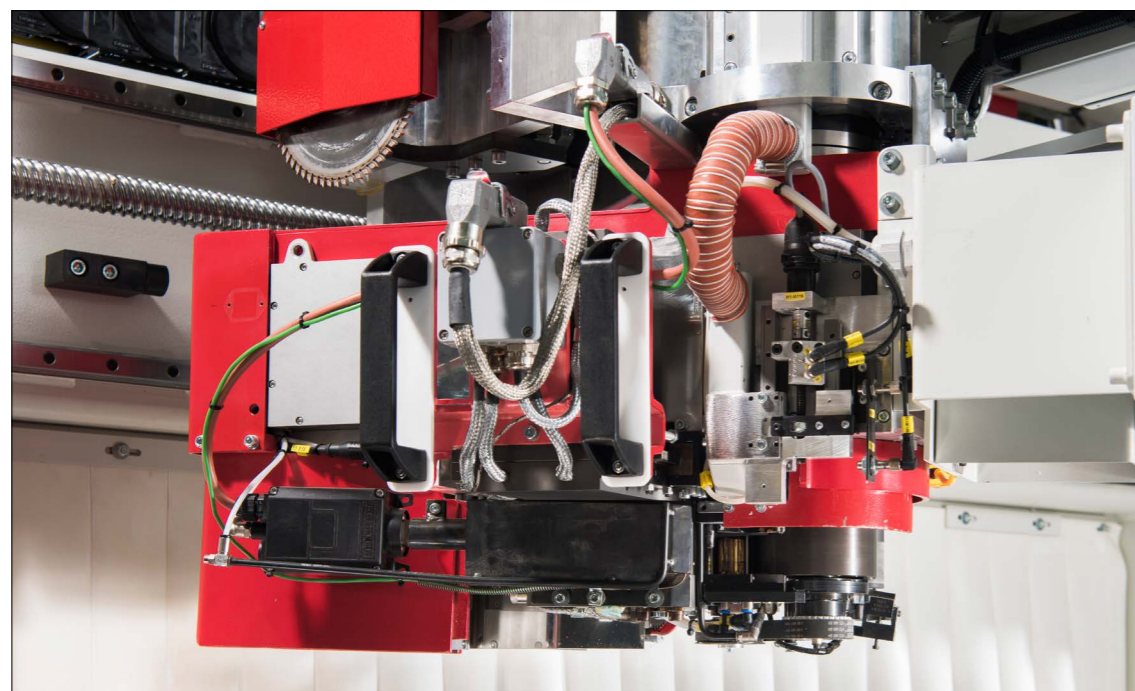
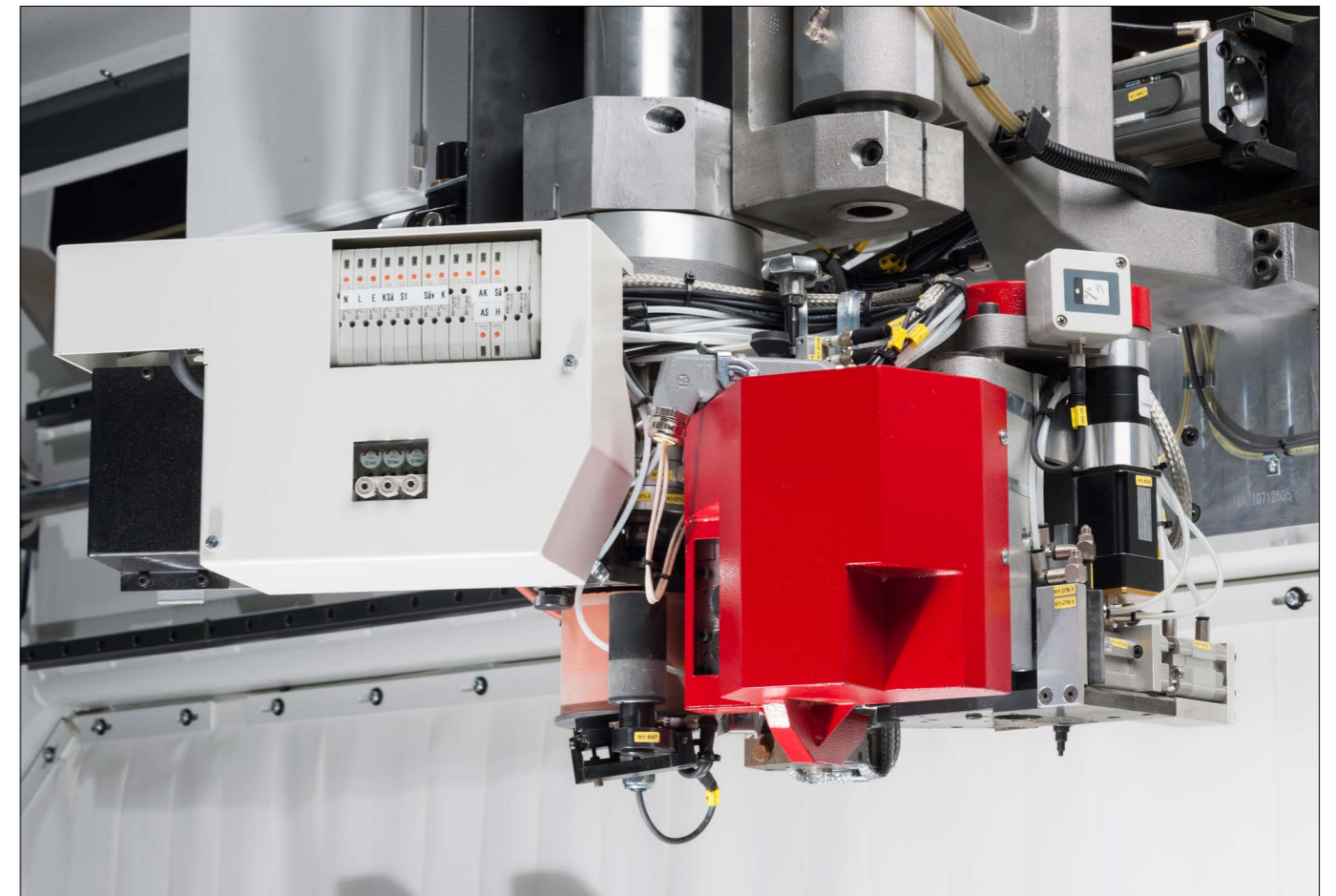

combined unit for EVA, PUR and laser edging

EDGE BANDING UNIT VT 50

- easy to open to allow quick cleaning (IMA patent), with a large package of optional features to extend its capabilities – the cost saving alternative:
- butt-joint edge banding is possible
- max. banding height 60 mm

EDGE BANDING UNIT VT 100

the professional solution for premium edge banding quality

- easy to open to allow quick cleaning (IMA patent)
- with fast access and high availability through a fixed structure (hence, reduction of production costs)
- integrated collision monitoring
- max. banding height 60 mm
- optional automatically angled gluing section (45°) VT 100/100 with max. gluing height 100 mm

DRILLING/MILLING

4-axis machining centre BIMA Cx40 for milling, sizing, profiling, grooving, sawing and boring of wooden, plastic, composite and lightweight materials.

ADVANTAGES DRILLING

- high performance drill head with 3000 – 9000 rpm for industrial application
- drive power 4 x 1,4 kW
- right-handed drill only, thus lower tool inventory

ADVANTAGES MILLING

- re-milling machining depth in Y up to 2000 mm with tool diameter 20 mm
- high-quality milling spindle with 10 kW (S6) air cooled or 18 kW (S6) water cooled
- optional vibration sensor to protect against tool imbalance
- adequate additional milling spindle with optional access to tool changer
- optional electrical sensor

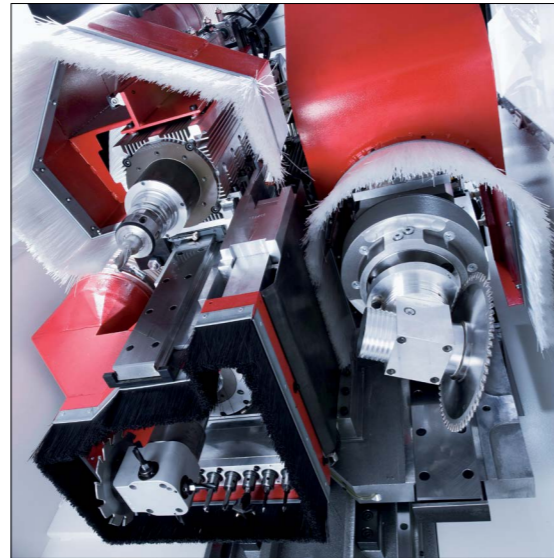

STRONG high-performance router spindle

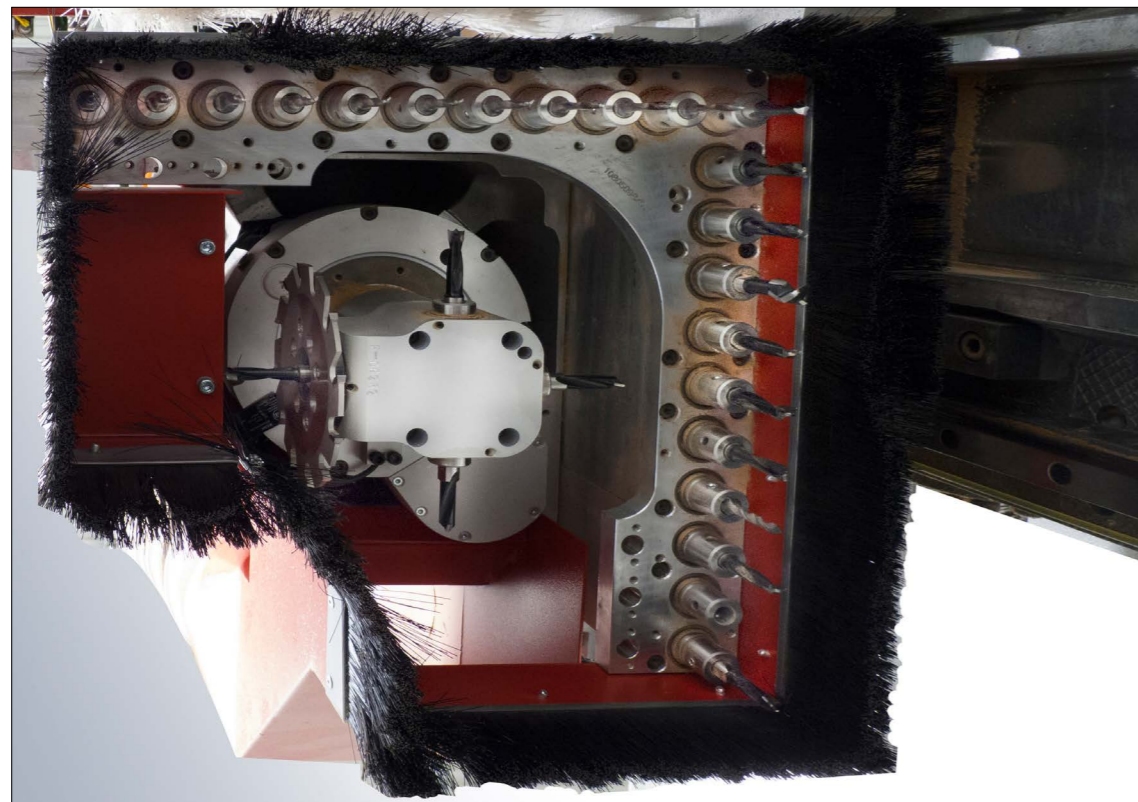

FLEXIBLE drilling unit with attachment units cross-head

HIGHEND - FINISH

A perfect finishing creates perfect results for your working pieces. Success with high-tech solutions from IMA.

AEK (IMA-PATENT)

- fully automatic processing combi unit
- patented new development of a future oriented technology
- up to 3 different profiles without tool change and without manual adjustments in one unit
- flush milling, profil scraping and optional glue scraper, three working processes with only one tool change
- automatic adjustment by control software and component-based data filling
- clear reduction of setup and tool change time for the highest possible availability of the machine
- optional edge thickness measuring for perfect results of every possible contour

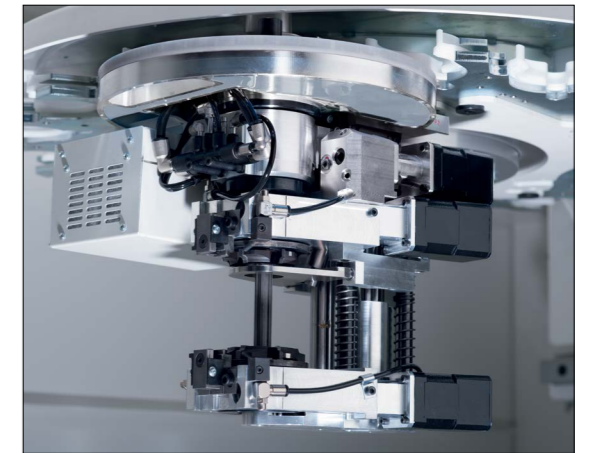

INDIVIDUELL: fully automatic processing combi unit AEK

COMBI UNIT

- patented combi unit
- 3 processes (flush milling, section drawing and glue scraping) in one unit with only one tool change

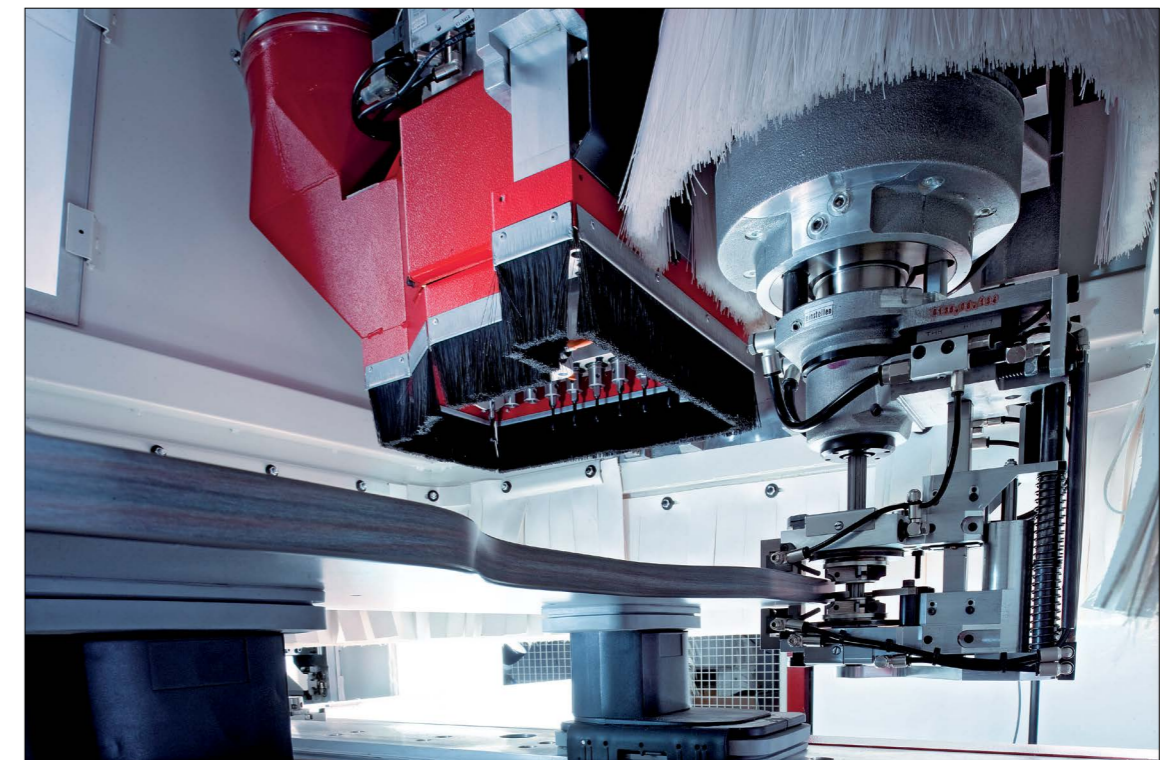

COMBI UNIT tracing finishing operation

5-AXIS MACHINING

The high-performance machining centre BIMA Cx40 R for flexible 3-D processing and all milling works:

Equipped for all future tasks:

- compact 5-axis robot head with cardan joint bearing and infinite axes (A+C)
- swivel range of the A axis between +90° and -10°
- interface that enables adapter units or tools with integrated compressed air or coolant supply to be fitted to the tool holder in an automatic process
- router spindle power 8.5 kW and 16 kW (S6) with an optimised torque curve in the lower speed range; max. speed 24000 rev/min.
- extraction hood control as a function of the application
- power-optimised central dust extraction

EFFICIENT PRODUCTION

The BIMA Cx40: thanks to its flexible unit mounting and variable straining possibilities, it meets all requirements.



WORK -HOLDING CLAMP for heavy duty milling



HORIZONTAL WORK - HOLDING CLAMP



SAWING /MILLING /DRILLING UNIT 0-100° MANUAL



TRACING MILLING UNIT

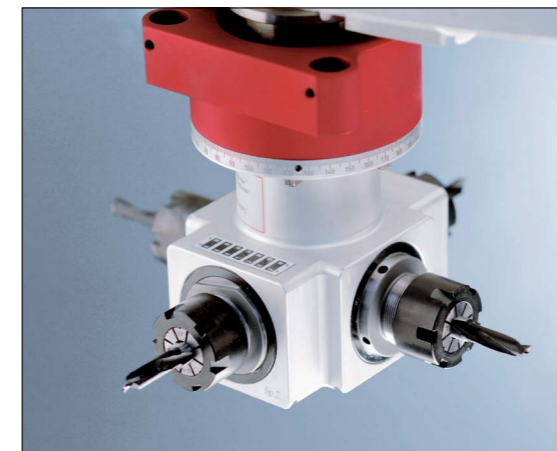

CROSSHEAD

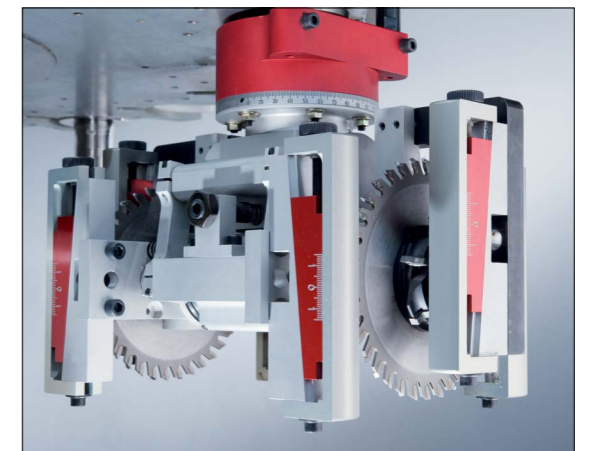

END TRIMMING AND CORNER ROUNDING

TABLE DESIGNS

The right worktable system, created for your work tools. The various systems of the BIMA Cx40 assure a customised solution.



CONSOLE TABLE

- quick and safe, manual setup
- significant reduction in setup time (up to 70 %) and increase in machine availability in contrast to conventional systems
- automatic suggestion for vacuum setting with IMAWOP
- free space under the consoles for simple swarf and waste disposal

AUTOMATIC SETTING TABLE

- fully automatic setup systems, no manual intervention required
- maximum positioning accuracy with positioning on linear guides for failure free operation and economic lifetime
- minimum positioning times to increase the productivity of the machine
- maximum independent positioning dynamics thanks to vacuum clamping block with separate Y drive (DynaPoint only)
- free space under the consoles for simple swarf and waste disposal
- extraction in pattern of 15 ° for optimal flexibility



optimal swarf and waste disposal under the consoles

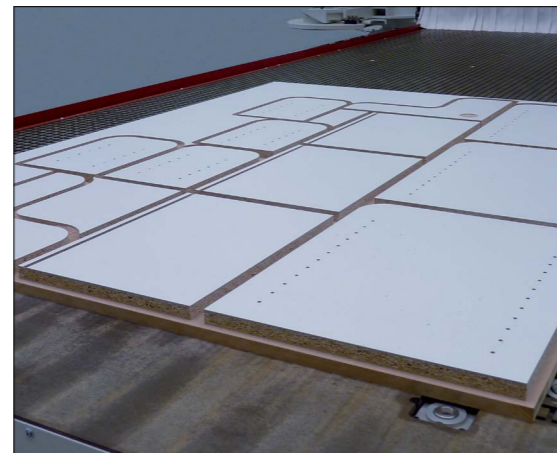

pattern table for maximum flexibility



IMAWOP - HIGHEST EASE OF USE

IMAWOP is the ideal operating control system with practice - tested software for flexible fabrication of different work tools. It is currently equipped with automatic preset time and working programs. Work tool movement and the of machining process can be simulated in 3D - for highest possible performance and safety.



IMAWOP CONTROL - OVERVIEW

- simple, graphic user interface/menu guidance - easy usability
- five-sided machining
- creation or take-over of CAD drawings of panels if required
- dynamic 3D auxiliary graphics for intuitive data entry
- IMA Quicktool for fully automatic machine-independent CNC programming for batch size 1
- process and processing time optimisation
- 3D interface for SolidWorks® and TopSolid®
- time recording
- DXF interface



3D COLLISION MONITORING and approval of the operational procedure already in your office

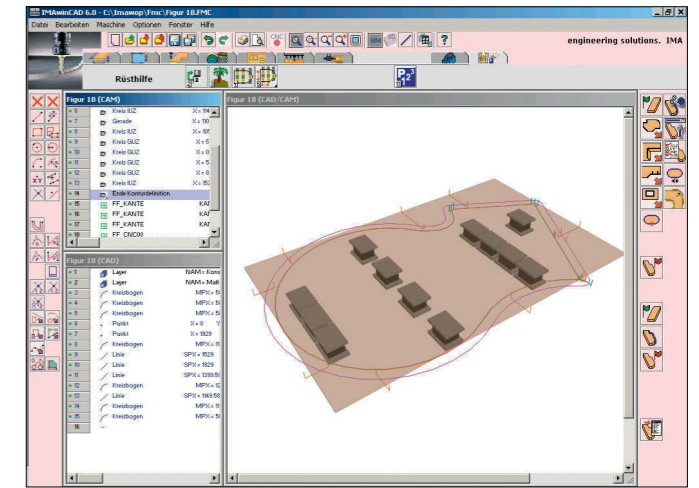

GRAPHIC 3D SIMULATION of the machining process with tool view and work-table view

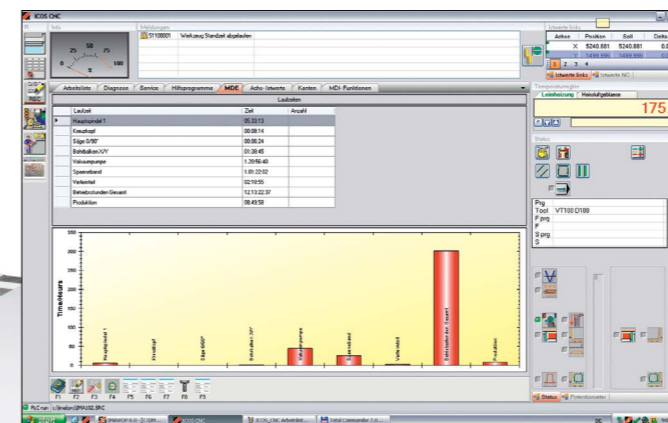

MDE BASIC acquisition of process and production data in standard

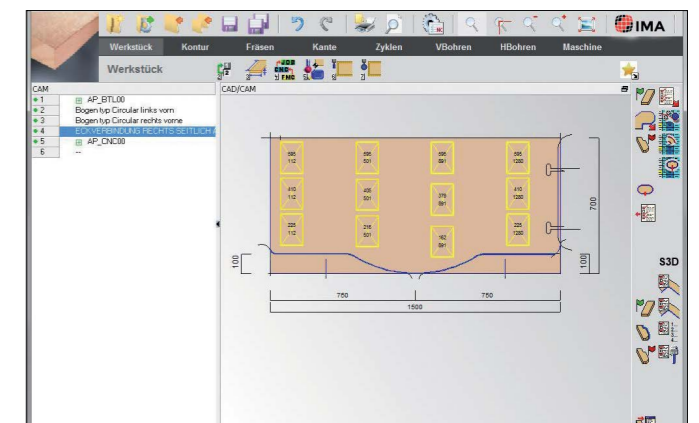

QUICKTOOL simple programming of complete and complex programs; it only takes a bit of input and a few mouse clicks to create an overall program



SERIES CX40

The complex BIMA Cx40 type requires little space and is equipped with an ideal dust extraction system. It shows high flexibility due to several different high-output adapter units. The complex gear units create a high dynamic in all axles.

	BIMA Cx40	BIMA Cx40 E	BIMA Cx40 R
working range			
X-direction	3.300 mm 4.300 mm 5.300 mm 6.300 mm 7.300 mm	3.100 mm 4.100 mm 5.100 mm 6.100 mm	3.000 (3.300) mm 4.000 (4.300) mm 5.000 (5.300) mm 6.000 (6.300) mm 7.000 (7.300) mm
Y-direction	re-milling machining depth in Y up to 2000 mm with tool diameter 20 mm 1450 mm with all units	re-milling machining depth in Y up to 2000 mm with tool diameter 20 mm 1450 mm with all units 1925 mm glueing	1450 mm (5-axis machining) 1600 mm (4-axis machining)
Z-direction	225 mm (incl. clamping device)		350 mm (incl. clamping device)
machine			
Main spindle	10-18 kW		16 kW
Tool changer	18- or 40-fold (optionally 18-fold moving in Y)		
C-axis	360°		5-axis robot head with cardan joint bearing
Vertical drilling spindles	14/21/24		
Horizontal drilling spindles	max. 8		
Edging	VT 50/VT 100/VT 100/100 - alternative - IMA Laser Edging Unit		
Sound level	Operation without processing 80 dBA [dependent on tools, feed speed and material]		
Central dust extraction connection	Ø 250 mm with slider control		
Software	Office version IMAWOP		
Tools	1 set of machining tools		

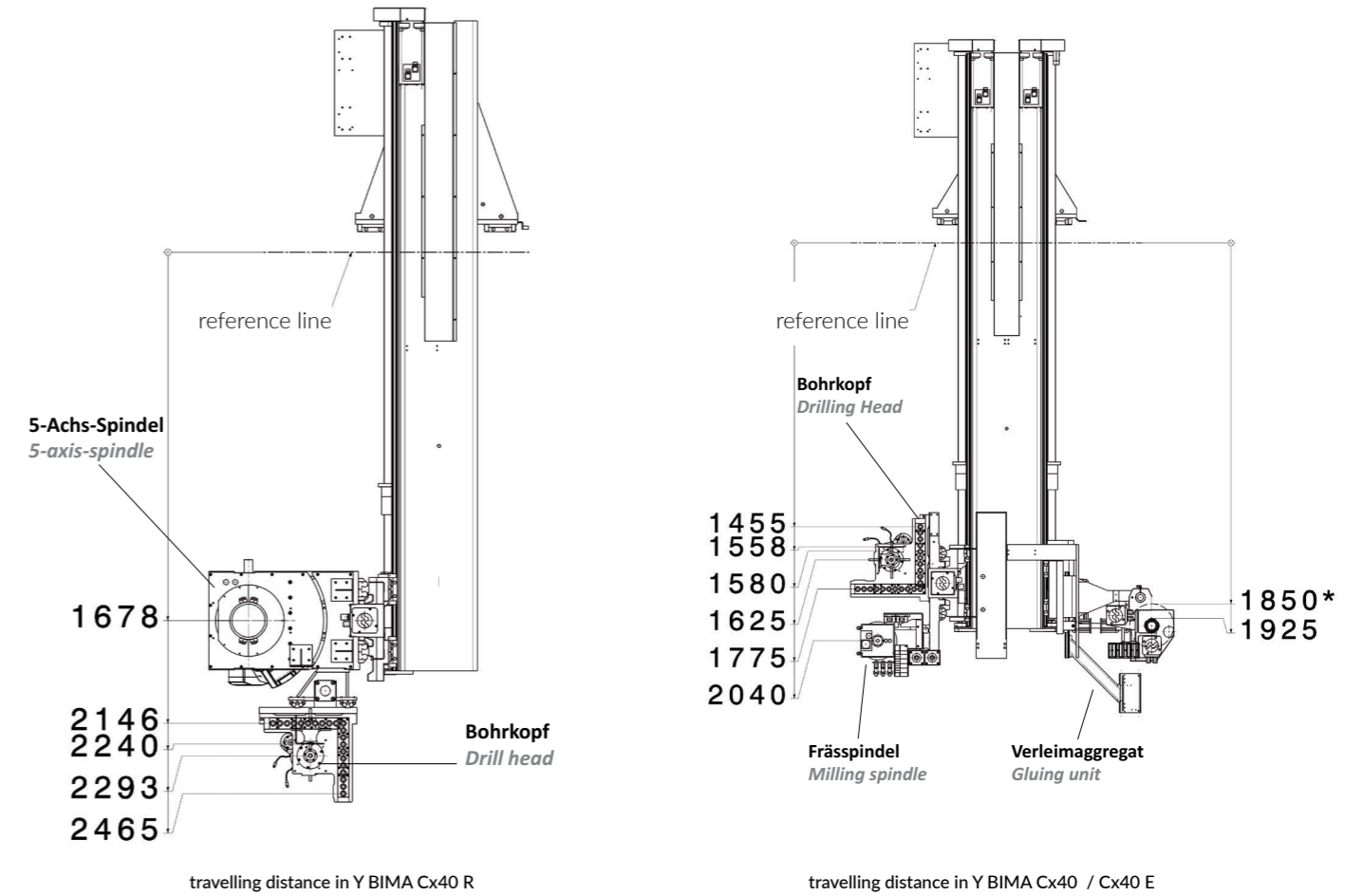

INDIVIDUAL EQUIPMENT POSSIBILITIES

- working area in X between 3000 mm and 7300 mm
- LED setup aid for up to 12 support bars
- automatic setup table / Dynapoint table (patterned table or flat table)
- 16 kW main spindle in S6 operation (for a 5-axis machine)
- additional spindle with complete functionality with capability to access the tool changer
- drilling unit with 14 to 24 vertical drill spindles (L- or T-shaped layout)
- special drilling units
- attachment units
- 18- or 40-station tool changer (18-station tool changer optionally travelling with the head assembly in Y-direction)
- pressure safety mats
- central extraction
- template connection
- touch-trigger probe for measurement points in X, Y and Z directions
- automatic centralized lubrication
- UPS (uninterruptible power supply)
- remote service VPN/basic system
- various special equipment for Non-Wood processing

TECHNICAL DATA

Typ	A single	B alternating	C dimension x	D dimension y
BIMA CX40				
145/330	3.300 mm	900 mm	8.600 mm	after individual specification
145/430	4.300 mm	1.400 mm	9.600 mm	
145/530	5.300 mm	1.900 mm	10.600 mm	
145/630	6.300 mm	2.300 mm	11.600 mm	
145/730	7.300 mm	2.800 mm	12.600 mm	
BIMA CX40 R				
145/300	3.000 mm	750 mm	8.600 mm	after individual specification
145/400	4.000 mm	1.250 mm	9.600 mm	
145/500	5.000 mm	1.750 mm	10.600 mm	
145/600	6.000 mm	2.250 mm	11.600 mm	
145/700	7.000 mm	2.750 mm	12.600 mm	
BIMA CX40 E				
145/310	3.100 mm	800 mm	9.850 mm	after individual specification
145/410	4.100 mm	1.300 mm	10.850 mm	
145/510	5.100 mm	1.800 mm	11.850 mm	
145/610	6.100 mm	2.300 mm	12.850 mm	

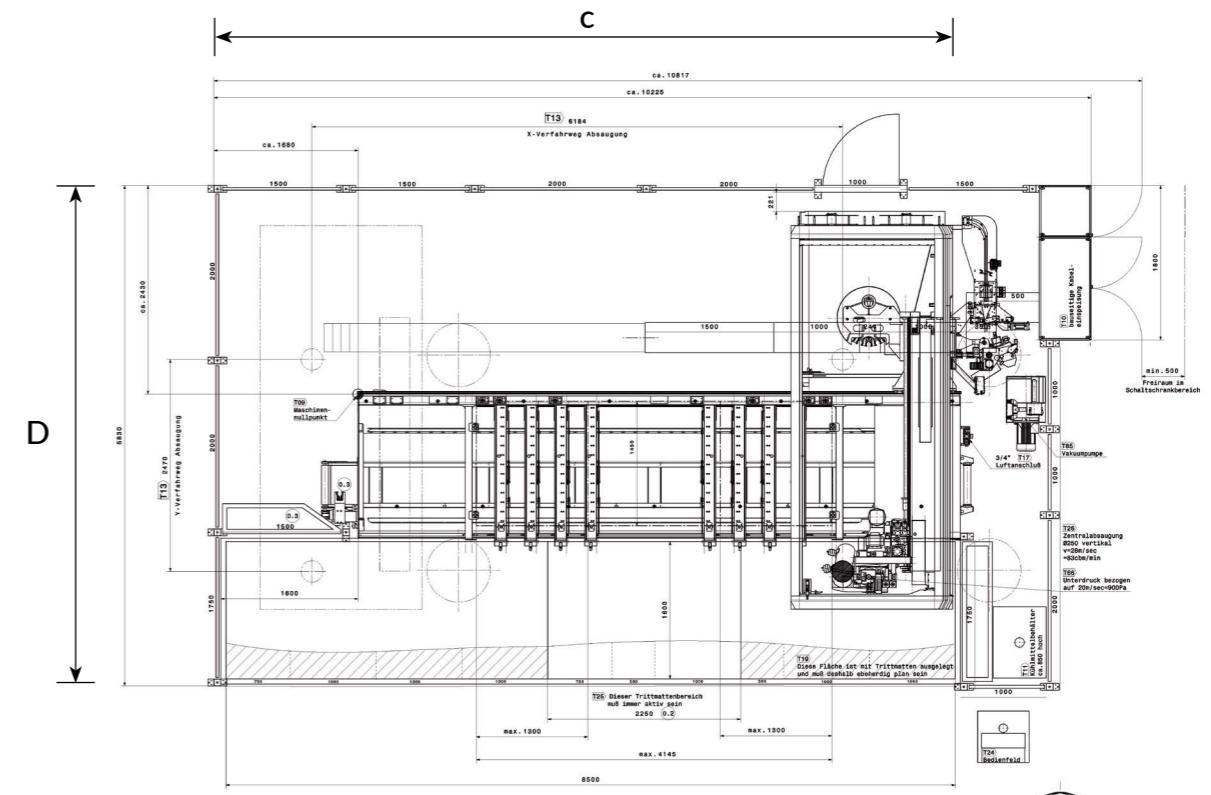

TOTAL DIMENSIONS: BIMA Cx40 R

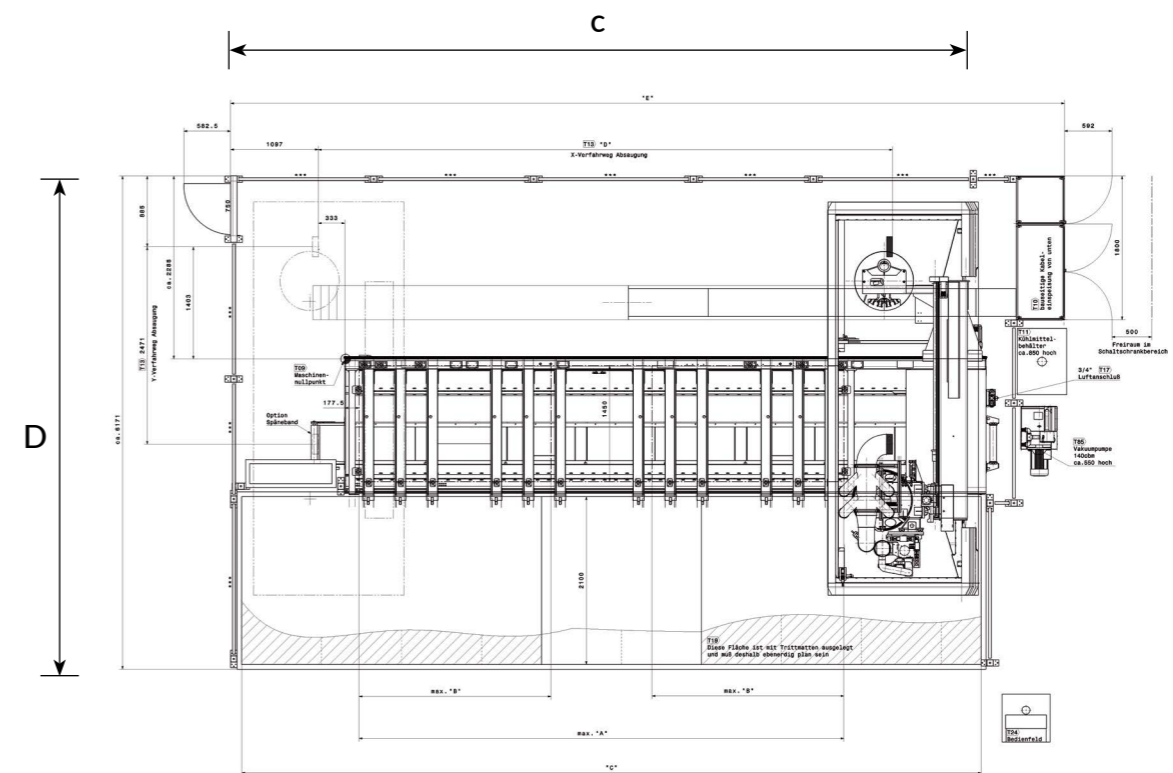

TOTAL DIMENSIONS: BIMA Cx40 E

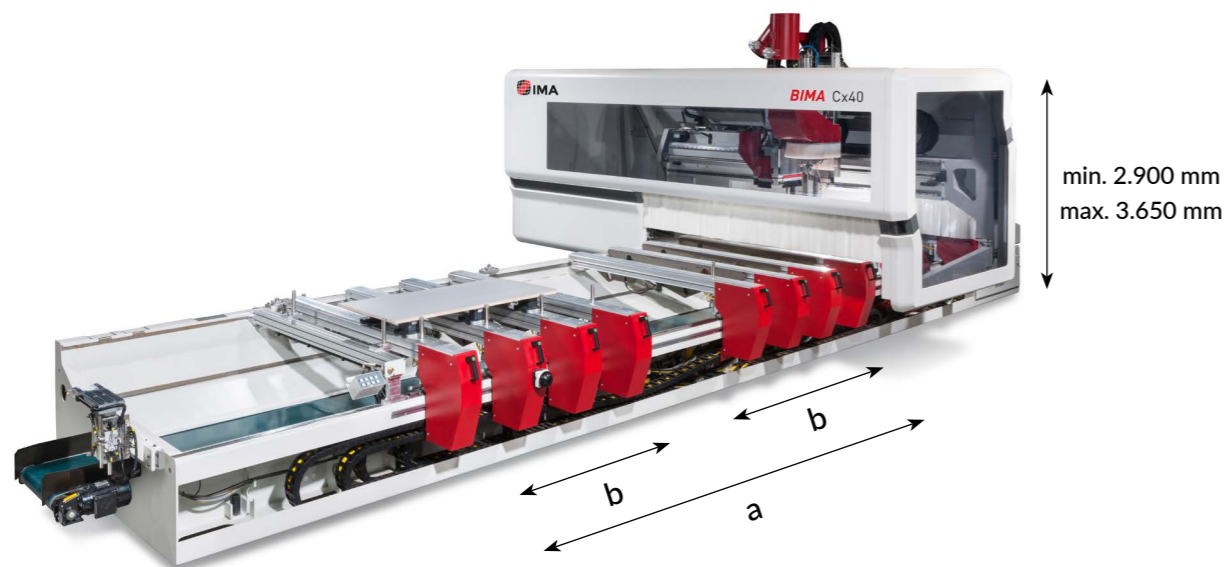



SERVICE

IMA service secures the business success of our customers. Because only easy accessibility, fast availability, capable and immediate worldwide help by telephone, remote maintenance of complex systems, the timely availability of spare parts and inspections make production process with IMA units and systems readily calculable.

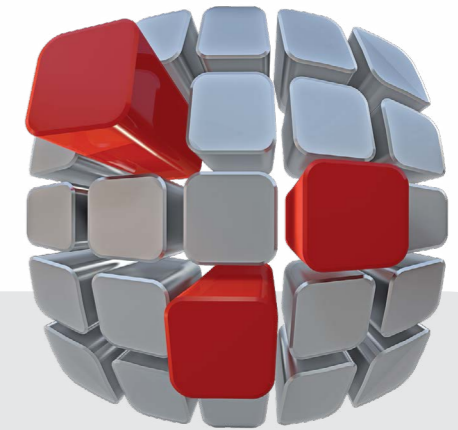

SERVICEPORTAL



The Serviceportal offers access around the clock to all the information related to your machine, makes service processes transparent and optimize machine availability.

SERVICE APP



The Service App for iPad and iPhone - the perfect supplement for the IMA service portal makes all the documents for your machine available in a mobile way.

PREVENTIVE MAINTENANCE



Standardised maintenance intervals and hence a reduction in unplanned downtime. This means security of planning for your production.

ONE GROUP – ONE GOAL: EXPERTISE IN DEVELOPING SOLUTIONS FOR THE WOODWORKING INDUSTRY

The IMA Schelling Group is a reliable partner for the implementing of sophisticated system solutions.
The demands of our customers are a daily challenge to us, our know-how and creativity!
We work with you to develop innovative and unique solutions for wood processing.

www.imaschelling.com

Modifications and mistakes reserved. Illustrations are approximate. Subject to technical modifications and mendments and to further developments.
The offer, respectively the order confirmation is relevant in either case! The picture of the machine could have been taken without complete protection devices.
The protection device is part of the scope of delivery. Photos could also be options, not being part of the scope of delivery and are not binding in detail.



IMA SCHELLING
GROUP